

Manual Supplement

Manual Title:	45 User	Supplement Issue:	2
Part Number:	855981	Issue Date:	5/01
Print Date:	January 1989	Page Count:	8
Revision/Date:	4, 7/97		

This supplement contains information necessary to ensure the accuracy of the above manual. Enter the corrections in the manual if either one of the following conditions exist:

1. The revision letter stamped on the indicated PCA is equal to or higher than that given with each change.
2. No revision letter is indicated at the beginning of the change.

For IEC 61010 1000V, CAT I & 600, CAT II Meters only. Serial NO. 7211001 and greater.

Change #1

Throughout the manual, replace all front and rear views of the meter with the following:

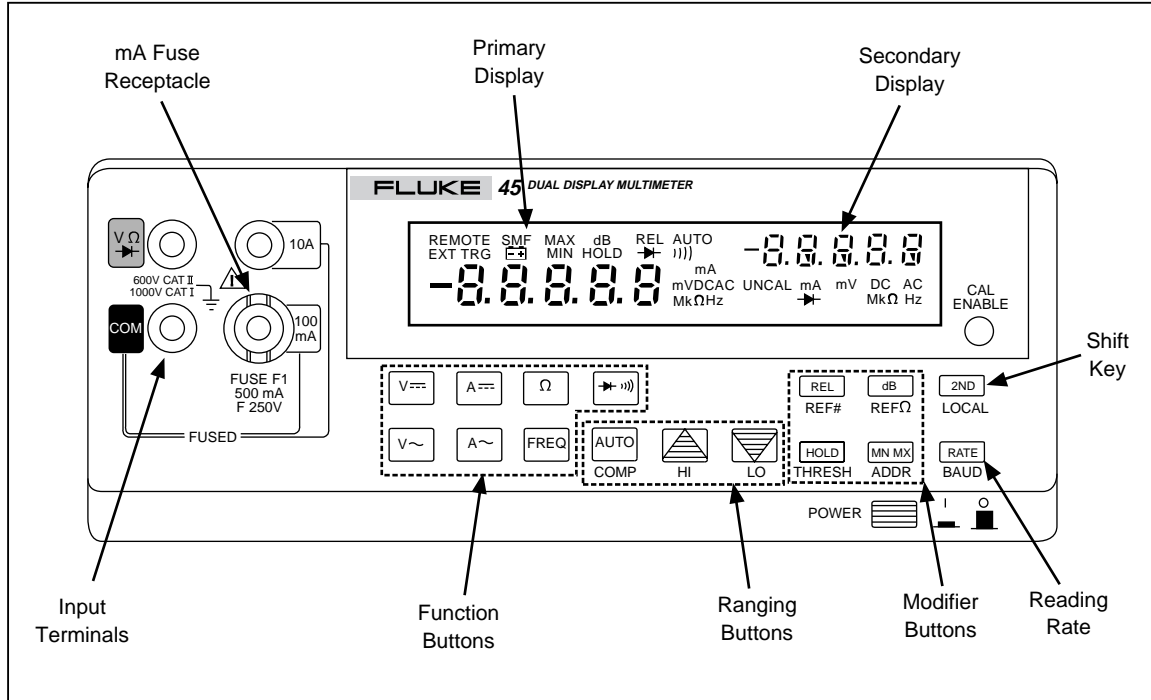

f2-1.eps

45 Front View

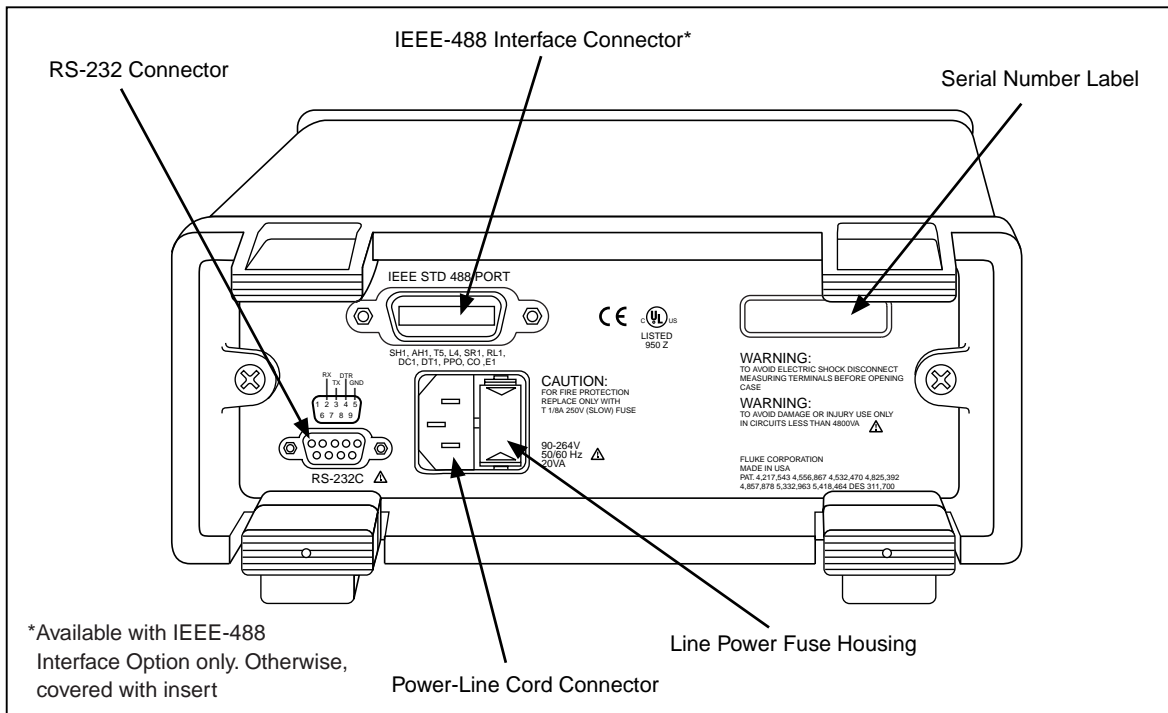

f2-1.eps

45 Rear View

*Available with IEEE-488 Interface Option only. Otherwise, covered with insert

On the page immediately following the warranty page, make the following changes:

Change the heading,

From: SAFETY CLASS

To: Caution

Remove the Declaration of the Manufacturer or Importer section.









Replace the MULTIMETER SAFETY page, immediately preceding Section 2, with the following:

Read First: Safety Information

This meter complies with ANSI/ISA S82.01-1994, CAN/CSA-C22.2 No. 1010. 1-92, EN61010.1:1993 to 1000 V Overvoltage Cat I, 600 V Overvoltage Cat II and UL3111-1. Use the meter only as specified in this Users Manual, otherwise the protection provided by the meter may be impaired.

Use the meter as described in this manual. Otherwise the safety features provided by the meter might be impaired. A **Warning** identifies conditions and actions that pose hazards to the user; a **Caution** identifies conditions and actions that might damage the meter. International electrical symbols used on the meter are shown in the following table.

Symbols

Symbol	Meaning
	Important information. See manual.
	Alternating current (AC)
	Direct current (DC)
	Alternating or direct current (AC or DC)
	Diode
	Ground
	Fuse
	Double insulation (Protection Class II)
	Conforms to European Union directives

Warning

To avoid possible electric shock or personal injury:

- **Do not use the meter if it is damaged. Before use, inspect the case for cracks or missing plastic. Pay particular attention to the insulation surrounding the connectors.**
- **Inspect the test leads for damaged insulation or exposed metal. Check test lead continuity. Replace damaged leads.**
- **Do not use the meter if it operates abnormally. Protection may be impaired. When in doubt, have the meter serviced.**
- **Do not operate the meter around explosive gas, vapor or dust.**
- **Do not apply more than the rated voltage, as marked on the meter, between terminals or between any terminal and earth ground.**

- **Before each use, verify the meter's operation by measuring a known voltage.**
- **When servicing the meter, use only specified replacement parts.**
- **Use caution when working above 30 V ac rms, 42 V ac peak, or 60 V dc. Such voltages pose a shock hazard.**
- **Keep your fingers behind the finger guards on the probe when making measurements.**
- **Connect the common test lead before connecting the live test lead. Disconnect the live test lead first.**
- **Do not operate the meter with the cover or portions of the cover removed.**
- **Connect the meter's line power cord to a power receptacle with earth ground.**
- **To avoid false readings, which could lead to possible electric shock or personal injury, recharge the meter's battery as soon as the low battery indicator ($\text{E} \oplus$) appears.**

Caution

To avoid possible damage to the meter or to equipment under test:

- **Disconnect the power to the circuit under test and discharge all high voltage capacitors before testing resistance, continuity or diodes.**
- **Use the proper jacks, function and range for your measurement applications.**
- **Check the meter's fuses, see the "Testing Current Input Fuses" section before measuring current.**

On page 2-6, make the following changes:

Under "Measuring Volts, Resistance, or Frequency", add the following:

Note

To minimize operator confusion, use first and second display operation to simultaneously monitor the AC and DC component of a measurement when both are present.

Caution

To avoid possible damage to the meter or equipment under test, disconnect the power to the circuit under test and discharge all high voltage capacitors before testing resistance, continuity or diodes.

Under "Measuring Current", preceding the first paragraph, add:

Caution

To avoid possible damage to the meter or equipment under test:

- **Use the proper jacks, function and range for your measurement applications.**
- **Check the meter's fuses, see the "Testing Current Input Fuses" section before measuring current.**
- **Never place the probes across (in parallel with) any circuit or component when the leads are plugged into the mA or A terminal.**
- **Never attempt an in-circuit current measurement where the open circuit potential to earth is greater than 1000 V.**

Under "Diode/ContinuityTesting", preceding the first paragraph, add:

Caution

To avoid possible damage to the meter or equipment under test, Disconnect the power to the circuit under test and discharge all high voltage capacitors before testing resistance, continuity or diodes.

On page 3-2, prior to "PRIMARY DISPLAY", add:

Note

To minimize operator confusion, use first and second display operation to simultaneously monitor the AC and DC component of a measurement when both are present.

On page 3-4, under "INPUT TERMINALS", in the second paragraph,

DELETE: against overloads

On page 3-5, replace Table 3-1 with the following:

Table 3-1. Maximum Rated Input

Function	Input Terminals	Maximum Rated Input*
V $\overline{\sim}$	V Ω \rightarrow \rightarrow and COM	1000 V dc or ac rms
V \sim and FREQ	V Ω \rightarrow \rightarrow and COM	1000 V ac rms, 2 x 10 ⁷ V-Hz normal mode, or 1 x 10 ⁶ V-Hz common mode (whichever is less)
mA $\overline{\sim}$ and FREQ	100 mA and COM	300 mA dc or ac rms protected with 500 mA, 250 V and 440 mA, 1000 V fuses.
A \sim and FREQ	10 A and COM	10 A dc or ac rms (or 20A dc or ac rms overload for 30 sec. max) protected with 11 A, 1000 V fuse.
Ω	V Ω \rightarrow \rightarrow and COM	1000 V dc or ac rms on all ranges
\rightarrow \rightarrow	V Ω \rightarrow \rightarrow and COM	1000 V dc or ac rms
All Functions	Any terminal to earth	1000 V dc or peak ac rms
* See specification for functional ranges		

On page 4-2, under "Taking Voltage and Current Measurements Using the Dual Display", preceding the first paragraph, add:

Caution

To avoid possible damage to the meter or equipment under test:

Check the meter's fuses, see the "Testing Current Input Fuses" section before measuring current.

Never attempt an in-circuit current measurement where the open circuit potential to earth is greater than 1000 V.

The voltage and current measurements must share the same common.

On page 6-1 under "Current Input Fuses", make the following changes:

Replace the first bulleted paragraph with the following:

- The 100 mA input is protected by two fuses. The first fuse, located in the front panel, is rated at 500 mA, 250 V fast blow, 1500 A minimum breaking capacity, IEC-127 Sheet I. The second fuse, located inside the case, is rated at 440 mA, 1000 V, 10,000 A breaking capacity. Use the exact replacements only.

Replace the second bulleted paragraph with the following:

- The 10 A input is protected by a fuse rated at 11 A, 1000 V fast blow, 17,000 A breaking capacity. Use the exact replacement only.

On page 6-2, under "Testing Current Input Fuses", following step 3, replace the paragraph with:

If the fuse is good, the meter will read between 11 and 15 Ω . If either mA circuit fuses are blown, the meter will read $> 10 M\Omega$ to OL. Check both the front panel fuse and the fuse inside the case.

On page 6-3, replace the entire "Replacing the 100 mA Input Fuse" section with the following:

Replacing the 100 mA Fuses

Warning

To avoid electrical shock or personal injury:

- **Remove any input signal, test leads, and meter's line power cord before replacing any fuse or opening the case.**
- **Install ONLY specified replacement fuses with the same speed, current, and voltage rating as shown in Table 6-5.**

The first 100 mA input fuse is mounted in the front panel input jack (see Figure 6-2). The second fuse is located inside the case on the main pca.

To replace the front panel fuse, first unplug the line cord. Then press in on the input jack and turn it 90 degrees counter-clockwise as shown in Figure 6-2. Slide out the fuse holder and fuse.

To replace the internal current fuse (1000 V, 440 mA) on the main pca:

1. Remove the single Phillips-head screw on the bottom of the case and the Phillips-head screw on each side of the rear bezel.

Warning

To avoid electrical shock or personal injury:

- **Remove any input signal, test leads, and meter's line power cord before replacing any fuse or opening the case.**
 - **Install ONLY specified replacement fuses with the same speed, current, and voltage ratings as shown in Table 6-5.**
2. Remove the bezel and slip the case back from the front of the meter. The fuse and fuse clip are visible at the front of the main printed circuit assembly (pca) near the input terminals.
 3. Carefully remove the fuse and replace it with one rated as listed in Table 6-5.
 4. Reverse the disassembly procedure to reassemble the meter.

On page 6-4, replace the WARNING with the following:

Warning

To avoid electrical shock or personal injury:

- **Remove any input signal, test leads, and meter's line power cord before replacing any fuse or opening the case.**
- **Install ONLY specified replacement fuses with the same speed, current, and voltage ratings as shown in Table 6-5.**

On page 6-9/6-10, Table 6-5, make the following changes:

Replace the entire F2 entry with:

F2 Δ Fuse, .406 X 1.5, 11 A, 1000 V, Fast 943118

Following the F3 entry, add the following:

F5 Δ Fuse, F44/100 A, 1000 Vac/Vdc 943121

Change the Service Manual part number,

From: 856042

To: 609203

On pages A-6 and A-7, replace the entire Maximum Input section with the following:

Maximum Input

IEC 664 Installation Category II.

mA Protected with a 500 mA, 250 V (fast blow), 1500 A breaking capacity, IEC-127 SHEET I fuse and a 440 mA, 1000 V, 10,000 A breaking capacity fuse.

A Protected with an 11 A, 1000 V, 17,000 A interrupt rating, fast blow fuse.

Note

Resistance between the COM binding post and the meter's internal measuring circuits is approximately $.003\Omega$

On page A-8,

Change: **Input Protection**

500V dc or rms ac on all ranges

To: **Maximum Rated Input**

1000 V dc or rms ac on all ranges

On page A-9,

Change: **Input Protection**

500V dc or rms ac on all ranges

To: **Maximum Rated Input**

1000 V dc or rms ac on all ranges

On page A-11 make the following changes:

Change the Common Mode Voltage specification,

From: 1000V dc or peak ac maximum from any input to earth

To: 1000V dc or ac rms maximum from any input to earth

Replace the Standards specification with:

Safety:

Compliant with the following standards:

ANSI/ISA S82.01-1994

CAN/CSA-C22.2 No. 1010. 1-92

EN61010.1:1993 to 1000 V Overvoltage Cat I, 600 V

Overvoltage Cat II, and Pollution Degree 2.

Meets FCC Part 15 Subpart J.

EMC: EN61326-1 (1998)

Change #2

On pages 6-6 and 6-7, Table 6-2, in the Ω function, under the INPUT LEVEL column, in both the "Using decades of 3:" and "Using decades of 1:" sections,

Change: short

To: short**

At the bottom of the table, add the following:

** Use either 2-wire compensation on the 5700A or the relative (REL) mode on the 45.

Change #3

On page A-8, in the OHMS table, under the Max Current Through the Unknown column replace all occurrences:

From: 150 μ A To: 150 nA
and
From: 320 μ A To: 320 nA